

YAMAHA CD-450

*Natural Sound Compact Disc Player
Original Music Processing LSI's
Double Resolution Digital Filter
Programmable Random Access Playback System
Index Search
Multi Function Display*

Thank you for purchasing the YAMAHA CD-450 Compact Disc Player

COMPACT
disc
DIGITAL AUDIO

CENTER

OWNER'S MANUAL



TABLE OF CONTENTS

Safety Instructions.....	2	Display Panel Information.....	9
Read This Section Before Operating Your CD Player.....	3	Pause and Stop Operations.....	10
Caution.....	4	Skip Operations.....	10
Transport Screws.....	4	Scan Operations.....	10
Front Panel Parts and Their Functions.....	5	Programmed Playback.....	11
Remote Control Parts and Their Functions.....	6	Repeat Playback.....	11
Battery Installation.....	7	Index Search.....	11
Rear Panel Parts and Their Functions.....	8	Timer Playback.....	12
Connections.....	8	Disc Care and Handling.....	12
Loading a Disc.....	9	Specifications.....	13
Normal Playback.....	9	Troubleshooting.....	14

IMPORTANT!

Please record the serial number of your unit in the space below.

Model: **CD-450**

Serial No.:

The serial number is located on the rear of the unit.

WARNING

To prevent fire and shock hazard, do not expose your CD player to rain or moisture.

CAUTION

Use of controls or adjustments, or performance of procedures other than those specified herein, may result in hazardous radiation exposure.

SAFETY INSTRUCTIONS

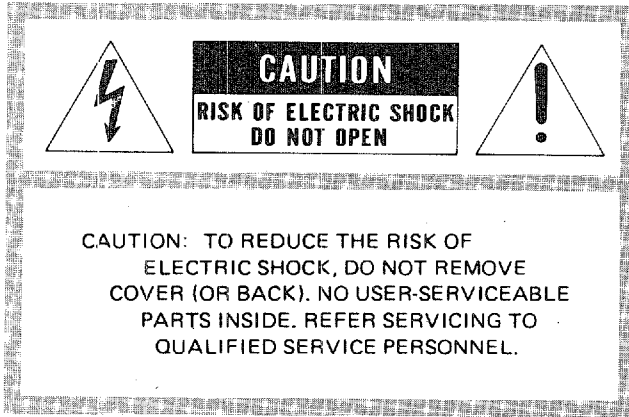

• Explanation of Graphical Symbols

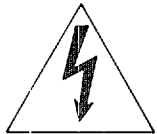

The lightning flash with arrowhead symbol, within an equilateral triangle, is intended to alert you to the presence of uninsulated "dangerous voltage" within the product's enclosure that may be of sufficient magnitude to constitute a risk of electric shock to persons.

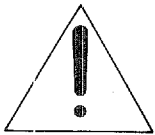

The exclamation point within an equilateral triangle is intended to alert you to the presence of important operating and maintenance (servicing) instructions in the literature accompanying the appliance.

1 Read Instructions — All the safety and operating instructions should be read before the appliance is operated.

2 Retain Instructions — The safety and operating instructions should be retained for future reference.

3 Heed Warnings — All warnings on the appliance and in the operating instructions should be adhered to.

4 Follow Instructions — All operating and other instructions should be followed.

5 Water and Moisture — The appliance should not be used near water — for example, near a bathtub, washbowl, kitchen sink, laundry tub, in a wet basement, or near a swimming pool, etc.

6 Carts and Stands — The appliance should be used only with a cart or stand that is recommended by the manufacturer.

7 Wall or Ceiling Mounting — The appliance should be mounted to a wall or ceiling only as recommended by the manufacturer.

8 Ventilation — The appliance should be situated so that its location or position does not interfere with its proper ventilation. For example, the appliance should not be situated on a bed, sofa, rug, or similar surface that may block the ventilation openings; or placed in a built-in installation, such as a bookcase or cabinet that may impede the flow of air through the ventilation openings.

9 Heat — The appliance should be situated away from heat sources such as radiators, stoves, or other appliances that produce heat.

10 Power Sources — The appliance should be connected to a power supply only of the type described in the operating instructions or as marked on the appliance.

11 Power-Cord Protection — Power-supply cords should be routed so that they are not likely to be walked on or pinched by items placed upon or against them, paying particular attention to cords at plugs, convenience receptacles, and the point where they exit from the appliance.

12 Cleaning — The appliance should be cleaned only as recommended by the manufacturer.

13 Nonuse Periods — The power cord of the appliance should be unplugged from the outlet when left unused for a long period of time.

14 Object and Liquid Entry — Care should be taken so that objects do not fall into and liquids are not spilled into the inside of the appliance.

15 Damage Requiring Service — The appliance should be serviced by qualified service personnel when:

- A. The power-supply cord or the plug has been damaged; or
- B. Objects have fallen, or liquid has been spilled into the appliance; or
- C. The appliance has been exposed to rain; or
- D. The appliance does not appear to operate normally or exhibits a marked change in performance; or
- E. The appliance has been dropped, or the cabinet damaged.

16 Servicing — The user should not attempt to service the appliance beyond those means described in the operating instructions. All other servicing should be referred to qualified service personnel.

**READ THIS SECTION BEFORE
OPERATING YOUR CD PLAYER**

- 1.** Your CD-450 is a sophisticated electronic unit. To ensure proper operation, and obtain the best possible sound reproduction, please read this manual carefully.
- 2.** Choose the installation location of your CD-450 carefully. Avoid placing it in direct sunlight or close to a source of heat. Also avoid locations subject to vibration or excessive dust, heat, cold or moisture. Keep away from such sources of hum as transformers or motors.
- 3.** Do not open the unit as this may result in damage to the set, or electrical shock to you. If any object should get into the unit, contact your dealer.
- 4.** When removing the power plug from the wall outlet, always pull directly on the plug, never yank the cord.
- 5.** Do not use excessive force when pressing the switches or.
- 6.** When moving the unit be sure to first pull out the power plug and remove the cords connecting it to other equipment.
- 7.** Do not attempt to clean your CD-450 with chemical solvents as this might damage the finish. Use a clean, dry cloth to clean it.
- 8.** Be sure to read the TROUBLESHOOTING section for advice on common operating errors before concluding that there is something wrong with your.
- 9.** Keep this manual in a safe place for future reference.

10. This equipment generates and uses radio frequency energy and if not installed and used properly, that is, in strict accordance with the manufacturer's instructions, may cause interference to radio and television reception. It has been type tested and found to comply with the limits for a Class B computing device in accordance with the specifications in Subpart J of Part 15 of FCC Rules, which are designed to provide reasonable protection against such interference in a residential installation. However, there is no guarantee that interference will not occur in a particular installation. If this equipment does cause interference to radio or television reception, which can be determined by turning the equipment off and on, the user is encouraged to try to correct the interference by one or more of the following measures:

- Reorient the receiving antenna
- Relocate the CD-450 with respect to the receiver
- Move the CD-450 away from the receiver
- Plug the CD-450 into a different outlet so that it and the receiver are on different branch circuits.

CD-450



If necessary, the user should consult the dealer or an experienced radio/television technician for additional suggestions. The user may find the following booklet prepared by the Federal Communications Commission helpful: "How to Identify and Resolve Radio-TV Interference Problems".

This booklet is available from the U.S. Government Printing Office, Washington, DC 20402, Stock No. 004-000-00345-4.

CD-450

CAUTION

Caution — Use of controls, adjustments, or performance of procedures other than those specified herein, may result in hazardous radiation exposure.

The compact disc player should not be adjusted or repaired by anyone except properly qualified service personnel.

DANGER—Invisible laser radiation when open and interlock failed or defeated.
AVOID DIRECT EXPOSURE TO BEAM. ICA07626 U

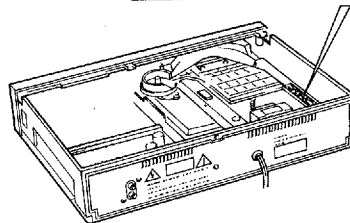

THIS PRODUCT COMPLIES WITH OHMS RULES 21 CFR SUBCHAPTER J APPLICABLE AT DATE OF MANUFACTURE

MANUFACTURED BY
NIPPON GAKKI CO. LTD.
10-1, ARAZAKI CHO, HAMAMATSU
SHIZUOKA KEN, JAPAN.

MANUFACTURED
date code

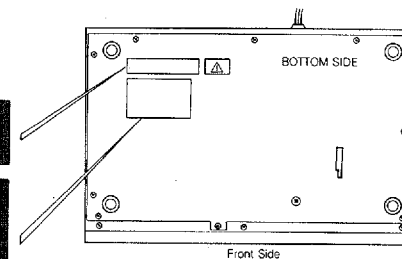

TRANSPORT SCREWS

To protect the internal laser pick-up mechanism from excessive shock during transit, it has been secured by special transport screws. These screws are attached on the bottom of the unit. Be sure to remove the transport screws before you turn your CD-450 on.

1. Carefully place the unit on its left side. Do not subject it to any shocks.
2. Use a Philips head screwdriver to remove the transport screws.
3. Place the screws in a safe place, perhaps with this manual, as they may be needed in the future.
4. If you are going to transport your CD-450 be sure to replace the transport screws. Be sure that there is no disc in the player before replacing the screws. Reverse the previous instructions to replace the screws.

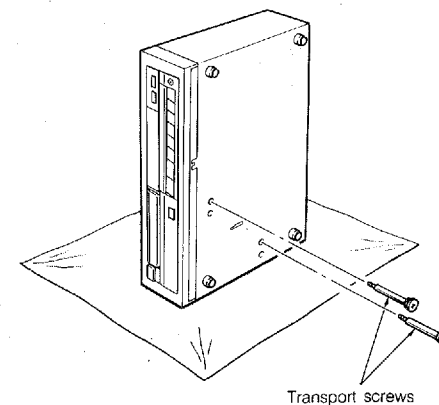

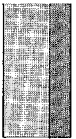

CD-450

FRONT PANEL PARTS AND THEIR FUNCTIONS

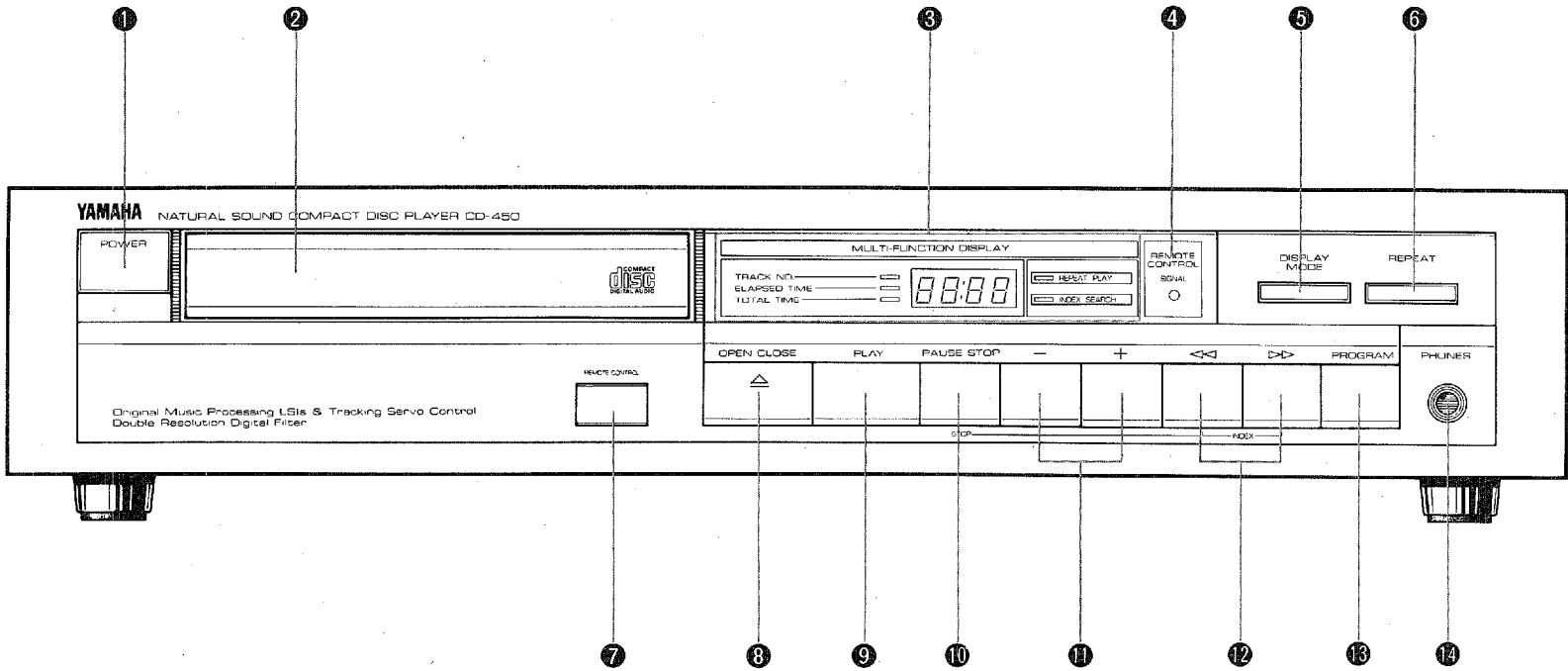

CD-450

① POWER Switch

Supplies power to your CD-450. If there is a disc in the disc tray, the player will begin playback from the first selection when power is turned on.

② Disc Tray

Holds a compact disc for playing. Slides out for loading and unloading when the OPEN/CLOSE switch is pressed.

③ MULTI-FUNCTION DISPLAY Panel

Provides comprehensive information on disc selections, disc playback status, player operating status, and all programming procedures.

④ REMOTE CONTROL SIGNAL Indicator

Lights to show that a signal is being received from the remote control unit.

⑤ DISPLAY Key

When pressed, changes the display contents a step at a time, from track number to elapsed time to total time and back to track number.

⑥ REPEAT ON/OFF Switch

Initiates automatic repeat playback of the entire disc, or of programmed disc selections.

⑦ REMOTE CONTROL SIGNAL Receptor

Used to receive signals from the remote control.

⑧ OPEN/CLOSE Key

When pressed, slides the disc tray out of the unit (OPEN operation) or retracts the disc tray into the unit (CLOSE operation).

⑨ PLAY Key

Initiates disc playback.

⑩ PAUSE/STOP Key

Pressing this key during playback will temporarily interrupt operation of the unit (PAUSE). Pressing it twice during playback (or once while PAUSEd) will cause the laser pick-up to return to the beginning of the first selection and STOP operation.

⑪ Skip Control Keys

Pressing these keys allows you to move the laser pick-up sequentially across the disc to the beginning of each selection, in either a forward (+) or reverse (-) direction.

⑫ Search Control Keys

Pressing these keys allows you to scan the laser pick-up sequentially across the disc in a forward (▶▶) or reverse (◀◀) direction when PLAYing or PAUSEd. In the Stop mode, these keys allow you to access the index markings which are encoded on some compact discs.

⑬ PROGRAM Key

Is used to set or check a disc selection program.

⑭ PHONES Jack

Connecting your stereo headphones here allows you to monitor disc playback.

REMOTE CONTROL PARTS AND THEIR FUNCTIONS

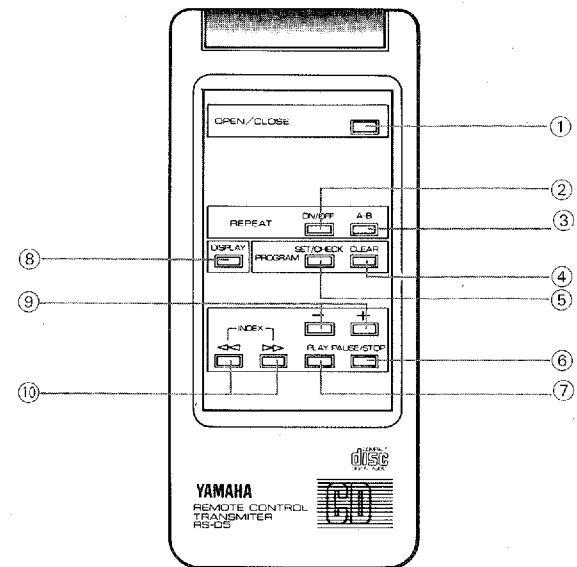

① OPEN/CLOSE key

Used to slide the disc tray out of the unit (OPEN operation) or to retract the disc tray into the unit (CLOSE operation).

② REPEAT ON/OFF Key

Used to automatically repeat playback of the entire disc, or of programmed disc selections.

CD-450

BATTERY INSTALLATION

③ REPEAT A ↔ B Key

Used to set starting and ending points for repeat playback. During play, pushing this key will cause the REMOTE CONTROL SIGNAL Indicator on the CD-450 to flash once and the Repeat Play Indicator to light. The point where the key was pushed will be point A. Pushing the key once more will cause the REMOTE CONTROL SIGNAL Indicator to flash once more. This will be point B. Play will then continue to repeat between points A and B.

④ PROGRAM CLEAR Key

Used to delete a previously stored track numbers from the programmed playback memory.

To use this function, first locate the track number you wish to delete with the PROGRAM SET/CHECK key. Then press the PROGRAM CLEAR key. That selection will be deleted from the program and all subsequent selections will decrease their program number by one.

⑤ PROGRAM SET/CHECK Key

Used to store a previously entered track number in the programmed playback memory.

⑥ PAUSE/STOP Key

Used during playback to temporarily interrupt operation of the unit (PAUSE). Pressing it twice during playback (or once while PAUSEd) will cause the laser pick-up to return to the beginning of the first selection and Stop operation.

⑦ PLAY Key

Used to initiate disc playback.

⑧ DISPLAY Key

Used to change the Time Display from Total Time to Remaining Time to Elapsed Time.

⑨ Music Search Skip Control Keys

Used to move the laser pick-up sequentially across the disc to the beginning of each selection, in a forward (+) direction or a reverse (-) direction.

⑩ INDEX Search Control Keys

Used to scan the laser pick-up sequentially across the disc in a forward (▶▶) direction or a reverse (◀◀) direction when PLAYing or PAUSEd.

The remote control unit uses 2 "AA" size batteries. Install them according to the following illustration. Be sure that they are installed correctly.

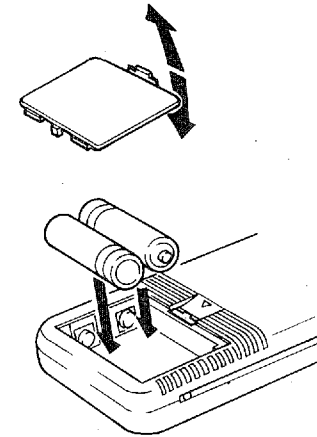

The remote control unit can be used up to about 7 meter (23 feet) from your CD player, and must be aimed in its direction for proper operation.

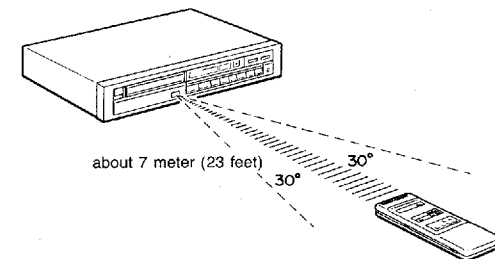

CD-450

REAR PANEL PARTS AND THEIR FUNCTIONS

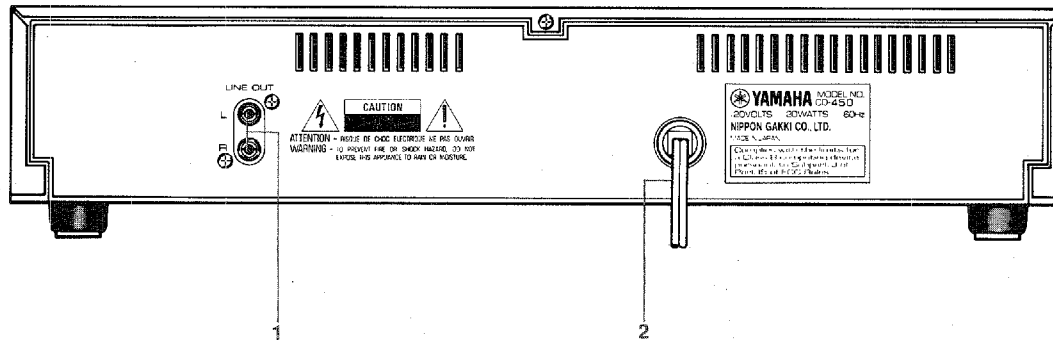

1. LINE OUT

Use these jacks to connect your CD-450 to an amplifier or receiver. They should be connected to the DAD, CD, or Aux input jacks. If these jacks are not available, use the TUNER or TAPE PLAY jacks. DO NOT use the PHONO input jacks. Make sure all AC power is off when making these connections.

2. AC Power Cord

Connect this cord to a wall AC outlet, or to the power outlet on your amplifier, tuner, timer, etc.

CONNECTIONS

There are only two connections to make from your CD-450: the AC power cord and the two LINE OUT jacks.

1. Make sure the transport screws are removed from the bottom of the unit.
2. Turn off the power to all units before making any connections.
3. Connect the LINE OUT jacks to the input jacks of your amplifier or receiver. They should be connected to the DAD, CD, or AUX input jacks. DO NOT use the PHONO input jacks. Be sure that the player right channel (RED) is connected to the right channel of your amplifier, etc. Likewise, be sure that the player left channel (WHITE) is connected to the left channel of your amplifier, etc.
4. Connect the power cord to an AC outlet or to the convenience outlet of your amplifier, tuner, etc. Be sure that the convenience outlet is rated for more than 20 watts.



LOADING A DISC

1. Press the POWER switch. The MULTI-FUNCTION DISPLAY Panel will display a flashing dotted line for a few seconds. This will change to the word "DISC", informing you that there is no disc loaded in the player. At this point, your CD-450 will only accept commands from the OPEN/CLOSE key.
2. Press the OPEN/CLOSE Key. The disc tray will slide out from the unit, and the display will change to the word "OPEN". If the disc tray is obstructed from opening it will stop in that position after approximately 4 seconds. Press the OPEN/CLOSE key again and the disc tray will close. Remove the obstruction and press the OPEN/CLOSE key again.
3. Load a compact disc. Once the disc tray is fully open, remove a compact disc from its case and, holding the disc by its edges, put it into the tray with the label facing upwards. At this point, your CD-450 will accept commands from the OPEN/CLOSE or PLAY keys, the Skip Control keys, or the Index Search keys.
4. Close the disc tray. You can close the disc tray in three different ways: by pressing the OPEN/CLOSE key, by pressing the PLAY key, or by gently pressing the tray inward. If the disc tray is closed by pressing the PLAY key, the compact disc will immediately start playing once the tray is fully closed, otherwise the unit will wait for further programming.
5. To remove a compact disc, simply press the OPEN/CLOSE key and wait for the tray to slide out. Then grasp the disc by its edges and lift it out. Remember to close the tray if you are not going to be using your player immediately.

NORMAL PLAYBACK

1. Press the POWER switch to turn your CD-450 on.
2. Slide out the disc tray by pressing the OPEN/CLOSE key and load a compact disc.
3. Press the OPEN/CLOSE key to retract the disc tray. After a few seconds the total number of selections on the disc will be displayed on the display panel for about three seconds. The display will then change to indicate the first track.
4. If you now press the DISPLAY key twice the TOTAL TIME of the disc (playback time from the beginning of the first selection to the end of the last selection) will be displayed on the Multi-function Panel.
5. Press the PLAY key to start disc playback. The display will change from the TOTAL TIME display to show PLAY and then to the TRACK NO. display, and playback will begin. If the PLAY key is pressed without pressing the OPEN/CLOSE key, the disc tray will retract and the word "PLAY" will immediately be displayed on the display panel. The display will change to the TRACK NO. when playback begins.
6. The entire disc will be played, from beginning to end, unless other commands are entered during playback. When the end of the disc is reached, the word "End" will be displayed for about three seconds. The display will then change to show TRACK NO. 1 when the laser pick-up automatically moves to the beginning of the first selection and stops.
7. You can stop playback of a disc at any time. Pressing the OPEN/CLOSE key will cause the disc to stop

playing, the disc tray to slide out for disc removal, and the display to show the word "OPEN". Pressing the PAUSE/STOP key once will cause the disc to stop playing. The laser pick-up will remain at that point on the disc and the TRACK NO. display will flash dotted lines. To resume playback at that point, press the PLAY key. Pressing the PAUSE/STOP key twice will also cause the disc to stop playing. But the laser pick-up will return to the beginning of the first selection and the TRACK NO. display will indicate the first selection. To resume playback simply press the PLAY key.

DISPLAY PANEL INFORMATION

The MULTI-FUNCTION DISPLAY Panel responds to every operation you make. It provides the following information, selected by pressing the DISPLAY key:

TRACK NO.: the number of the current selection on the disc

ELAPSED TIME: the elapsed playback time of the current selection, in minutes and seconds

TOTAL TIME: the combined playback time for all selections on the disc, or of a random access program, in minutes and seconds. This can only be displayed when the disc is STOPped. When playback begins, TOTAL TIME will switch to TRACK NO.

During playback, and during a PAUSE, you can alternate between TRACK NO. and ELAPSED TIME by pressing the DISPLAY key. All programming operations are prompted

CD-450

and confirmed on the display (dISC, OPEN, PLAY, and End), and all disc search operations are confirmed with each operation.

The panel also includes indicators to confirm REPEAT PLAY, REPEAT A-B PLAY, INDEX SEARCH, INDEX playback, and Remote Control operation.

The following display appears when the STOP mode is engaged and the laser returns to the first track on the disc.

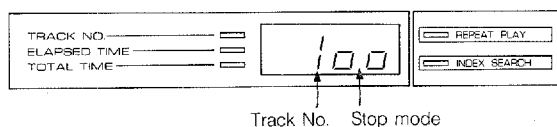

PAUSE AND STOP OPERATIONS

Once a disc is loaded and playback has begun, pressing the PAUSE/STOP key once causes playback to PAUSE. The disc stops playing, but the current location of the laser pickup is maintained. When PAUSEd, a dotted line will flash on the TRACK NO. display, or the colon between the minutes and seconds on the ELAPSED TIME display will flash, according to which display has been selected. Disc scan and Track skip operations may be done while PAUSEd. To resume playback press the PLAY key. Pressing the PAUSE/STOP key twice during playback (or once when PAUSEd) will cause playback to STOP, and the laser pick-up to move to the beginning of the first selection. Track Skip operations may be done while STOPped. To resume playback press the PLAY key. If you CD-450 is in programmed playback, Track Skip operations will only work for those selections placed in memory. For example, you will skip from selection 2 to selection 6 by pressing the

“+” Skip Control key if those programs follow each other in the program. Disc Scan operations, however, follow the order on the disc. They do not skip the tracks that are not part of the program. Scanning from selection 2 to selection 6 will take you into selection 3 and so on. If you stop scanning outside of the program that track will finish, and then playback will resume with the next selection in the program.

SKIP OPERATIONS

The Skip Control keys allow you to move sequentially to the beginning of the next track on the disc, in either a forward or reverse direction. You can skip tracks when PAUSEd, STOPped, or while PLAYing.

To move forward one track press the “+” key and the laser pick-up will move to the beginning of the next track. If pressed and held down, the pick-up will continue moving to the next track, and then the next, until the end of the disc is reached.

To move backward one track press the “-” key and the laser pick-up will move to the beginning of the current selection (if playing that selection), or to the beginning of the previous selection. If pressed and held down, the pick-up will continue moving to the previous track until the beginning of the disc is reached.

When skipping tracks, the display will change to the new TRACK NO. every time one of the keys is pressed, then return to the ELAPSED TIME display if that had been selected previously.

During programmed operation, the Skip Control keys will move the pick-up only to the programmed selections, and will pass over the tracks not selected.

SCAN OPERATIONS

The Search Control keys allow you to scan across the disc in either a forward or reverse direction. You cannot scan while the disc is STOPped.

If either of the keys are pressed during playback ($\blacktriangleright\blacktriangleright$ for forward and $\blacktriangleleft\blacktriangleleft$ for reverse), the laser pick-up begins scanning at a faster than normal speed for about 3 seconds, then at a higher speed for as long as the switch is held down. Music can be heard, but muted to about one-fourth normal volume, allowing you to monitor the selections while trying to locate a specific passage on the disc.

If either of the keys is pressed when the disc has been PAUSEd, the disc is scanned in the same manner, but no sound is heard.

After scanning, the previous mode is maintained (PLAY or PAUSE). If the end or beginning of the disc is reached during scanning in either direction, the laser pickup does not return to the other end to continue scanning.

During programmed operation, the Search Control keys will move the pick-up across all the selections, not just the programmed ones. For example, if the program has track 9 following track 4 and you press the $\blacktriangleright\blacktriangleright$ Search Control key while PLAYing track 4, the scan will go into track 5 after track 4, not into track 9. When track 5 is finished, play will then resume with track 9 in such a case. If you stop the scan while PLAYing a track that is not in the program, that track will finish playback and then the next selection in the program will start to PLAY.

If the $\blacktriangleright\blacktriangleright$ key is held until the end of the last selection on a disc is reached, the player will automatically enter the STOP mode.

PROGRAMMED PLAYBACK

You may program your CD-450 to playback only certain tracks on a disc, in any order you wish to hear them. Up to 9 selections can be programmed, or only one selection. The player automatically inserts a 3 second audio blank space between playback of each selection. Programming can be done only when the disc is STOPped. To enter a program you use the PROGRAM key and the Skip Control keys.

1. Press the PAUSE/STOP key to STOP playback and move the laser pick-up to the beginning of the first selection on the disc.
2. Press the PROGRAM key. The display will change, with the TRACK NO. indicator lit and PROGRAM number "P1" displayed

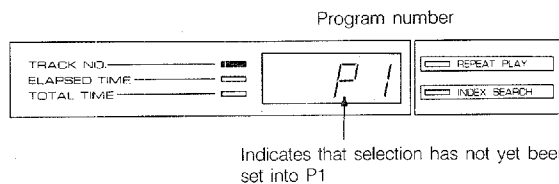

3. Locate the first desired selection by using the "+" key to advance to the beginning of that track, if it is not the first track. The display will show a flashing number (i.e. "3" for the third track) indicating the selected track, followed by "P1", indicating the first program.

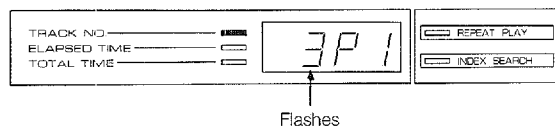

4. Press the PROGRAM key to enter the selection as P1. The display will change to the prompt "P2" and the

selected track number will disappear.

5. Use the Skip Control keys to move to the next desired selection. When the correct TRACK NO. is flashing on the display press the PROGRAM key again to enter the selection as P2.
6. Continue moving to the desired selections and entering them.
7. Once you have entered the last desired selection or have reached P9, press the PROGRAM key one more time. The display will change to the word "End", and after about 3 seconds your CD-450 will be ready to play, with the laser pick-up positioned at the beginning of the first selected track and the display showing no track number but PROGRAM number "P1".

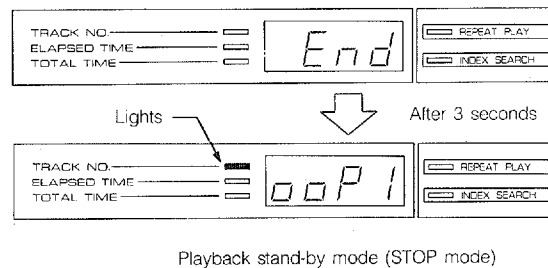

8. Press the PLAY key to begin playback. When programmed playback is finished, the unit will automatically stop and move the laser pick-up to the beginning of the first selected track. Your selection program will remain in memory until the disc tray is opened or power is turned off. To review a program in memory CD-450 must be STOPped. Press the PROGRAM key once for each track entered into the program. Both PROGRAM selection

number and actual TRACK NO. will be displayed. The PAUSE/STOP key and Skip Control keys will all function as in normal playback, but only those tracks entered into memory will be affected.

If the Search Control keys are used during programmed playback, the CD-450 will change to normal playback as you scan across the tracks. When the track you have moved to has finished PLAYing, the next track in the program will begin to PLAY.

When the end of a program is reached during PLAY operations the display will change to the word "End". The display will change to indicate "P1" when the laser pick-up moves to the beginning of the first selection in your program.

You can change, but not delete, the program by first locating the program number you wish to change with the PROGRAM key, then following the procedure for program setting.

REPEAT PLAYBACK

Press the REPEAT switch to continuously playback the entire disc or the programmed selections. The REPEAT PLAY indicator will light on the display. To stop repeat playback press the REPEAT switch once again, and the indicator will go out.

INDEX SEARCH

The Search Control keys are also used when your CD-450 has been STOPped. When the disc is STOPped, these keys allow you to move the laser pick-up to an index mark



CD-450

in a selection.

Index marks are special encoded stops within a single track on a compact disc. These are not present on all discs, but are likely to occur on classical music discs to identify the beginning of an individual movement within a symphony, since a symphony would constitute a single track. Index search allows you to locate these index marks and begin playback from them.

Please note that the index marks cannot be used with programmed playback.

1. Enter the Stop mode.
2. Select the desired track number with the Skip Control keys.
3. Press the Search Control keys (**▶▶** for forward and **◀◀** for reverse) to move to an index mark. The INDEX SEARCH indicator on the display panel will light, and the display will change to show both the TRACK NO. and the INDEX number within that track.
4. Continue pressing the Search Control keys to locate the desired index mark. Once the index mark is located press the PLAY key to begin playback from that point.

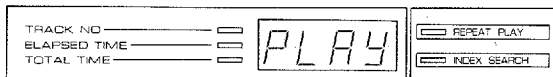

5. To stop playback press the PAUSE/STOP key, otherwise playback will continue past the next index mark until the end of the disc.
6. Index selection numbers will be displayed if the Index Search function is used with discs that do not have Index

markers. When PLAY is initiated, however, it will start from the beginning of the Track already selected.

7. If an Index number is selected that is greater than the number of actual Index markers on the disc, PLAY will begin from the final Index marker on the disc.
8. In some cases, playback may begin slightly before the index mark.

TIMER PLAYBACK

Your CD-450 can be set to start playback at a desired time by using it in combination with an external audio timer.

1. Connect your CD-450 and associated equipment to a commercially available audio timer.
2. Place the input selector of your amplifier or receiver to the position corresponding to your CD-450 input jacks.
3. Load a disc into your CD-450.
4. Set the volume and tone controls to the desired levels.
5. Program the desired ON and OFF times into the audio timer.
6. When the preset time arrives, power will be supplied to the CD-450 and playback will automatically begin.

DISC CARE AND HANDLING

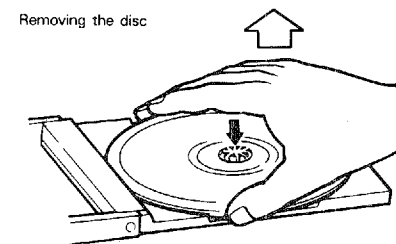
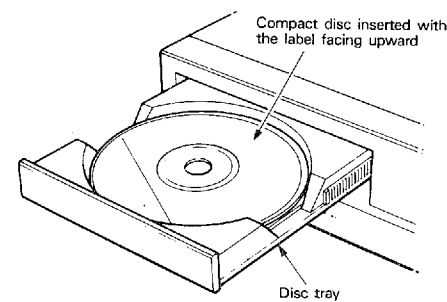
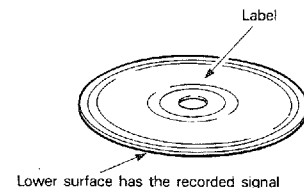

Proper way to hold compact disc

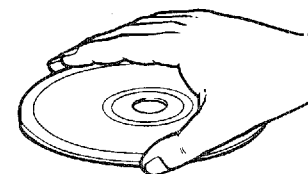

CD-450

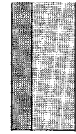

SPECIFICATIONS

Your CD-450 has been specifically designed for the reproduction of compact discs bearing the "CD" mark. No other discs should be loaded into the player.

To remove a disc from its storage case, press down on the center of the opened case and lift the disc out, carefully holding it by the edges.

Always place the disc in the tray with the label facing up. Although compact discs are impervious to wear during play, damage to the surface of a disc through improper handling will result in playback irregularities. To preserve your compact discs, please handle them with care.

Although minute dust particles and fingerprints should have no effect on playback, you should keep the surface of the recorded side of your discs clean by wiping them with a clean, dry cloth. Wipe in a straight motion from the inside to the outside.

Never use record cleaner, record spray, antistatic sprays or liquids, or any chemical-based liquid to clean the surface of a disc, as these may irreparably damage the disc's plastic surface. Always return a disc to its protective plastic case when not using it.

Avoid exposing discs to direct sunlight, high temperature, or high humidity for extended periods of time. Long exposure to high temperatures may warp a disc.

Do not write on the label side of the disc with a ballpoint pen, as this may damage the disc.

AUDIO SECTION

Frequency Response.....	5 to 20 kHz +0.5 dB, -1.0 dB
Harmonic Distortion + Noise.....	0.004% (1 kHz)
S/N Ratio.....	98 dB
Dynamic Range.....	95 dB
Wow & Flutter.....	Unmeasurable
Channel Separation.....	Better than 90 dB (1 kHz)
Output Voltage.....	2 V rms (full scale)
Output Impedance.....	1 k-ohm
Headphone Output (8 ohms).....	150 mV/8 ohms

INTERNAL SYSTEMS

Optical Pick-up.....	3-beam laser
Error Correction System.....	CIRC
D/A Conversion.....	16-bit linear
Filter.....	Digital filter and 3rd order active filter

GENERAL

Power Requirements.....	120 VAC, 60 Hz
Power Consumption.....	20 W
Dimensions (W x H x D).....	435 x 94 x 290 mm 17-1/8" x 3-3/4" x 11-3/8"
Weight.....	4.2 kg 9 lbs. 40 oz.
Accessories.....	Connecting cord

Note that all specifications are subject to change without notice.



CD-450

TROUBLESHOOTING

If your CD-450 fails to operate normally, check the following points to determine whether the fault can be corrected by the simple measures suggested. If it cannot, or if the fault is not listed in the SYMPTOM column, disconnect the player's power cord and contact your dealer or service center for help.

SYMPTOM	CAUSE	CURE
The player fails to turn on when the POWER switch is pressed.	Power cord is not plugged in or not completely inserted.	Firmly plug in the power cord.
The disc tray does not close completely.	A foreign object is entangled in the tray.	Carefully check the disc tray and remove the foreign object.
dISC appears on the display when trying to playback.	The disc has been inserted upside down.	Load the disc correctly
	The disc is damaged.	Check the disc carefully and replace if necessary.
	There is moisture on the laser pick-up.	Wait 20 to 30 minutes after turning the unit on before trying to playback a disc.
Playback does not begin.	Disc is loaded upside down.	Reload the disc with the label side up.
	Disc is dirty.	Clean the disc.
Playback is delayed, or begins at the wrong place.	The disc may be scratched or damaged.	Check the disc carefully and replace if necessary.
No sound.	Improper output cable connections.	Connect cables properly. If the problem persists, the cables may be defective.
	Improper amplifier operation.	Set the amplifier controls to the correct input selection.
Sound "skips".	Player subject to vibrations or shock.	Relocate the player.
	Disc is dirty	Clean the disc.
Sound "hums".	Improper cable connections.	Firmly connect the audio plugs. If the problem persists the cables may be defective.
Noise in the tuner.	Tuner too close to the player.	Move the tuner away from the player.
Noise from within the disc tray.	The disc may be eccentric.	Replace the disc.